



# 2 Low Unloc Differential Kit

Front Axle Disconnect Kit for 2WD Low Range Operation





|                |                                       |                  |
|----------------|---------------------------------------|------------------|
| <b>1030710</b> | <b>Chevrolet Silverado/GMC Sierra</b> |                  |
|                | <b>1500</b>                           | <b>2001-2013</b> |
|                | <b>2500/3500</b>                      | <b>2001-2014</b> |
| <b>1030711</b> | <b>Chevrolet Silverado/GMC Sierra</b> |                  |
|                | <b>1500</b>                           | <b>2014-2018</b> |
|                | <b>2500/3500</b>                      | <b>2015-2018</b> |

*NOTE : This kit is for both automatic and manual transfer case trucks.*

BD Engine Brake Inc.  
 Plant Address: 33541 MacLure Rd. Abbotsford, BC, Canada V2S 7W2  
 U.S. Shipping Address: 1124 Fir Avenue, Blaine, WA 98230 U.S. Mailing Address: P.O. Box 231, Sumas, WA 98295  
 Phone: 604-853-6096 | Fax: 604-853-8749 | Internet: [www.bddiesel.com](http://www.bddiesel.com)

## Kit Contents

All kits include

| 1300910   | 1003335   | 1210347  | 1300131   |
|---|---|--|---|
|  |  |  |  |
| Rocker Switch<br>Qty: 1   | Switch Decal<br>Qty: 1  | Relays<br>Qty: 2   | Tie Wrap<br>Qty: 6  |

Included in kit 1030710

| 1300710   |
|---|
|  |
| Wiring Harness (Early Model)<br>Qty: 1  |

Included in kit 1030711

| 1300711  |
|--|
|  |
| Wiring Harness (Late Model)<br>Qty: 1  |

## Table of Contents

|                                       |   |
|---------------------------------------|---|
| Kit Contents .....                    | 2 |
| Table of Contents.....                | 2 |
| Introduction .....                    | 3 |
| Operation .....                       | 3 |
| Tools Required for Installation ..... | 3 |
| Installation.....                     | 4 |
| Wiring Diagram .....                  | 6 |
| Other Switch Options .....            | 7 |

## Introduction

Vehicle maneuverability is reduced when 4WD modes are engaged as the front and rear axles are directly connected through the transfer case. This makes it very difficult to use the vehicle in low range except in straight lines or slippery conditions.

The BD 2 Low Unloc Differential Kit allows the operator to disable the front wheel drive mechanism by not allowing the differential to engage the front axle. By keeping this disengaged, full torque is available to the rear wheels. This allows for sharp turns with full steering travel without the front axle hopping or binding.

When the 2 Low Unloc is turned on, the front wheels will NOT be driven. This allows for normal two wheel drive maneuverability while in low range. This is very helpful for backing up trailers, and other special maneuvers.

## Operation

The 2 Low Unloc is controlled using a rocker switch mounted on or below the dash. When the switch is in the off position, the truck operates normally and will lock the front axle when in 4WD. When the switch is turned on, this will disable the engagement of the front axle lock, only allowing 2WD operation.

To access 2WD low range, turn the rocker switch on *first*. Then, move the transfer case selector or lever to 4WD low range. The rocker switch will now light up showing that it is disabling the front axle lock and the truck will be able to operate in 2WD.

To ensure reliable operation, engage the 2 Low Unloc *before* switching the transfer case to 4WD. The load put on the front axle from the transfer case when in 4WD may not allow the front axle locking mechanism to engage or disengage correctly.

When the truck is in 2WD low range, torque output is multiplied by gear reduction. All of this power will be transferred to the rear axle only. *We recommend not aggressively applying throttle in 2WD low to prevent possible drivetrain damage.*

**NOTE** Do not leave this unlock device enabled in 4x4 high range as this will cause the front drive shaft and differential to be driven without doing any work. This will reduce fuel economy and create unnecessary driveline drag.

## Tools Required for Installation

- Knife
- Small file
- Stepped drill bit and drill

**Note** If the switch is not being permanently mounted in the dash, the file and drill bit are not required.

# Installation

1. Open the hood, locate the front axle harness connector, it will be a 4 pin connector located on the driver side of the engine bay, near the fuse box.

If difficult to locate, follow the harness from the front axle. (figure shown)

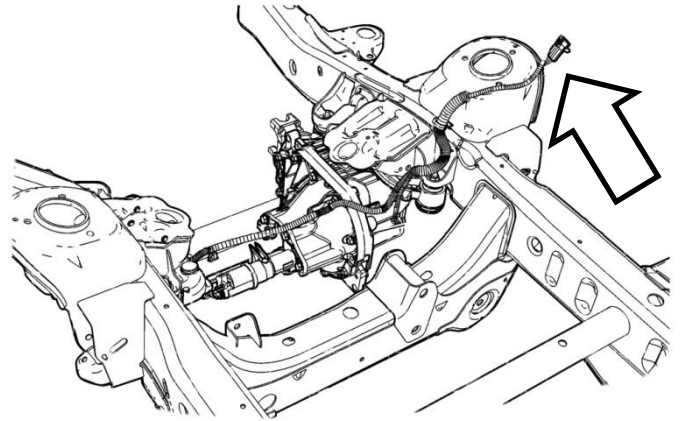

2. **2011-2014 6.6 Diesel (LML)**  
The connector is attached to the rear lower side of the ECM bracket.



3. Unplug the harness connector and connect the BD harness inline.

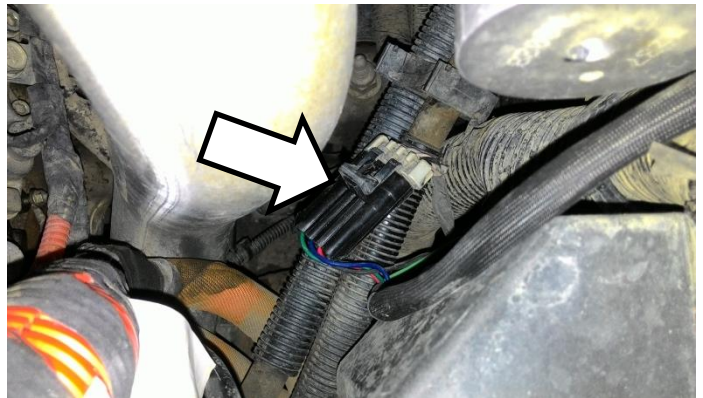

4. **All other models**  
The connector is beside or below the fuse box on the inner fender. Connect the BD harness inline.

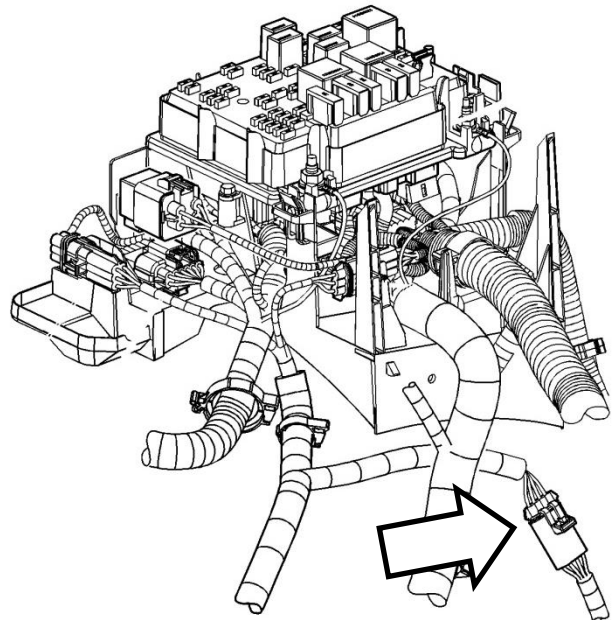

5. Install the two supplied relays into the BD wiring harness.

Using the supplied wire ties, secure the relays in the engine bay. These may be tied to a nearby wiring harness or attached to the fire wall.



6. Locate a suitable place to run the wires through the firewall. If there are already accessory wires routed through the firewall use the same route. Otherwise cut a new slit in the firewall grommet.

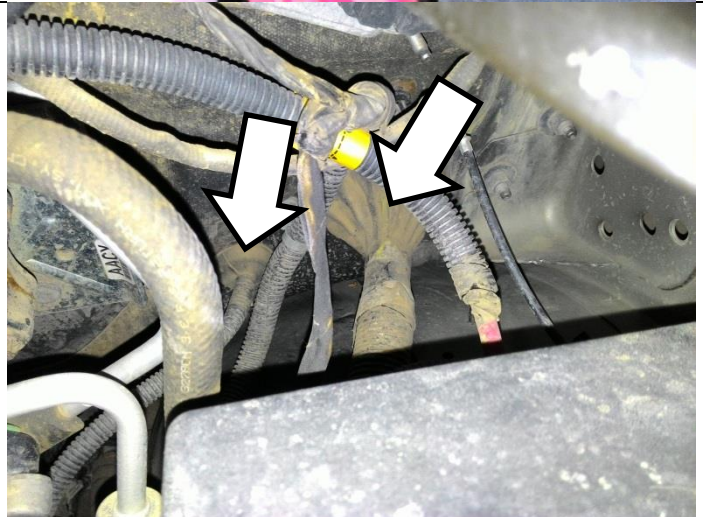

7. Fish the switch wires through the firewall to below the dash.

8. Locate a suitable spot to mount the switch.



9. Using the stepper drill bit, create a hole to mount the switch (Approx. 13/16"). Use the small file to create a notch to locate the switch. The supplied decal may be used as a template for the hole size.

Apply the supplied "2WD LOW" sticker over the hole before installing the switch.



- 10. Once the switch is installed, connect the three spade terminals to the switch.

Dark blue to top (behind light)  
Pink to middle  
Red to bottom



## Wiring Diagram

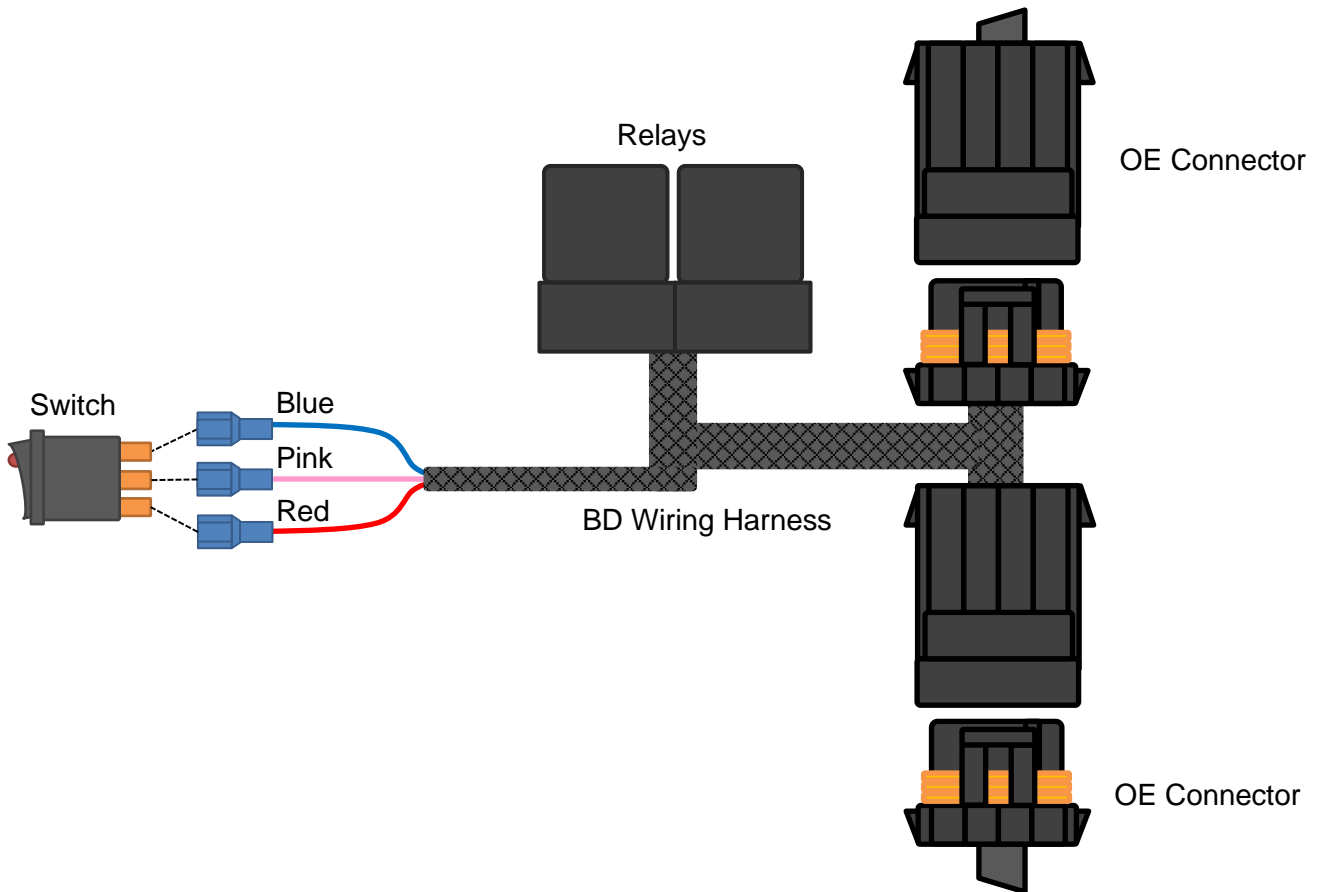

# Other Switch Options

The rocker switch in this kit may be replaced with another switched 12v power source if desired. To enable the 2WD Low Unlock, feed power to the pink wire. If using a customer supplied switch, connect both the red and pink wires to the switch to enable the 2WD Low Unlock. If the switch has an illumination feature, connect the blue wire (this is a switched ground).

## Other Switched Power Source

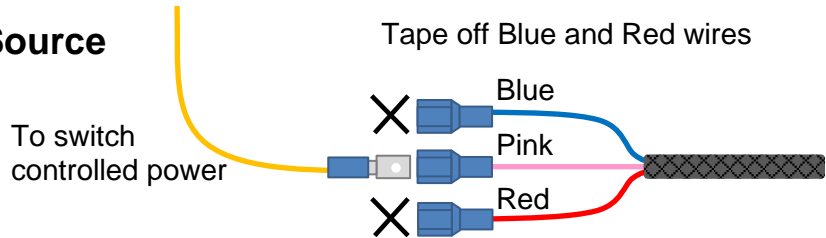

## Customer Supplied Switch

Blue wire may be attached to illumination terminal on switch. It is a switched ground. If unused, tape it off.

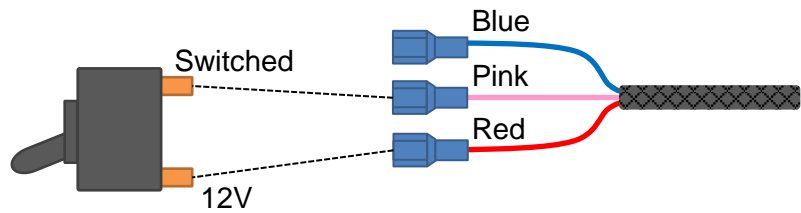

If you have any technical difficulties, concerns, comments, or complaints, please phone our Technical Support hotline at (800) 887-5030 between 8:30am-5:00pm PST (Pacific Standard Time) Monday to Friday.